

DK Series



The Passionate Pursuit of Perfection

www.bole-machinery.com

BOLE Customer Service Center

BOLE MACHINERY

ADD: No.99 Weisan Road, Xiaogang, Ningbo, China

PC: 315821

TEL: +86-574-86188007

FAX: +86-574-86188008

E-mail: bole-sales@bole-machinery.com

THIS CATALOGUE ARE PROTECT BY LAW OF COPY RIGHT.
ANY USE WITHOUT THE EXPRESS PERMISSION OF THE LAW OF COPY RIGHT,
MUST GET APPROVAL OF SHUANGMA IN ADVANCE.

THIS VERSION WAS PRINTED IN JULY 2019,
ANY DIFFERENCE SPECIFICATION FROM OLD VERSION SHOULD BE SUBLCT TO THIS VERSION.

DK Series Two Platen Injection Moulding Machine

German Origin

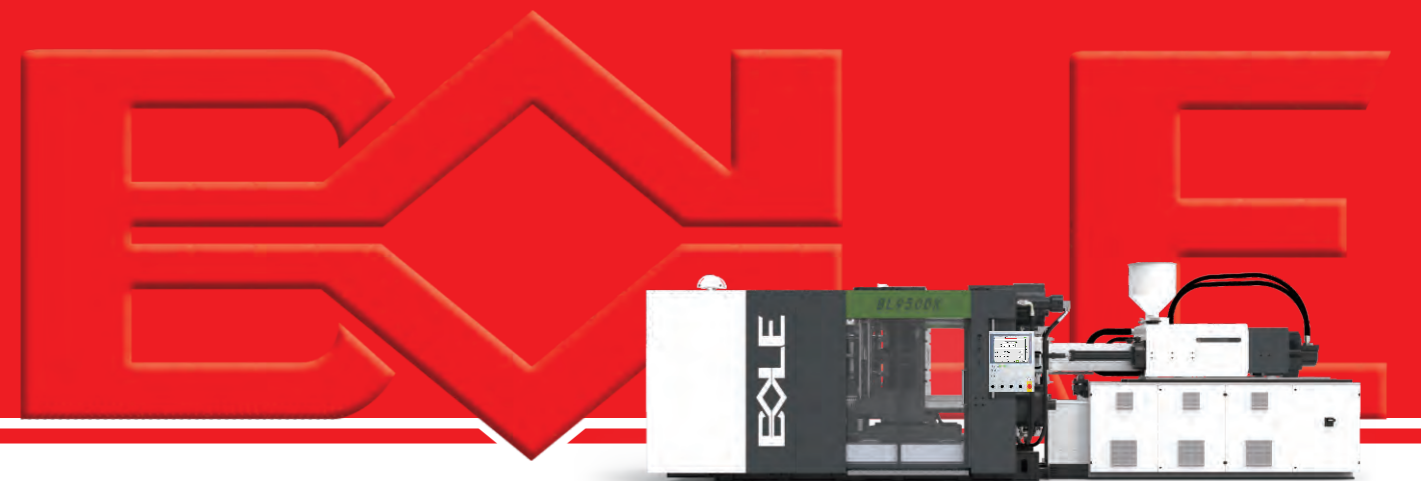

Injection Moulding Machine

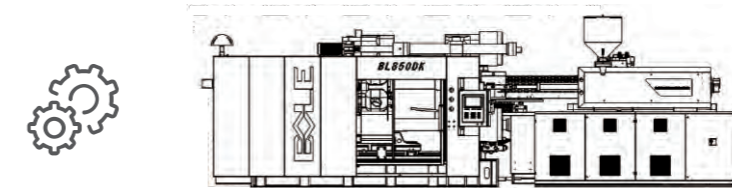

Operate independently to ensure German quality and present European performance perfectly.

More than 100 tests, more than 20 patents, speed, accuracy, stability are increased, It will become the first choice in automobile industry compared with European products.



Automobile industry

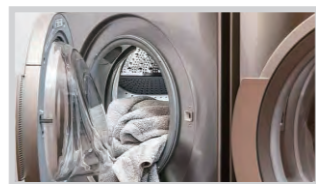

Household electrical appliance industry



Deep cavity product

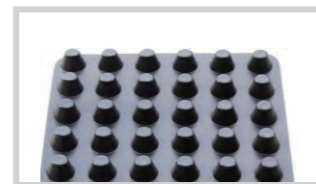

Logistics building material





Two Platen
Injection Moulding Machine

Technical Pain Points in China

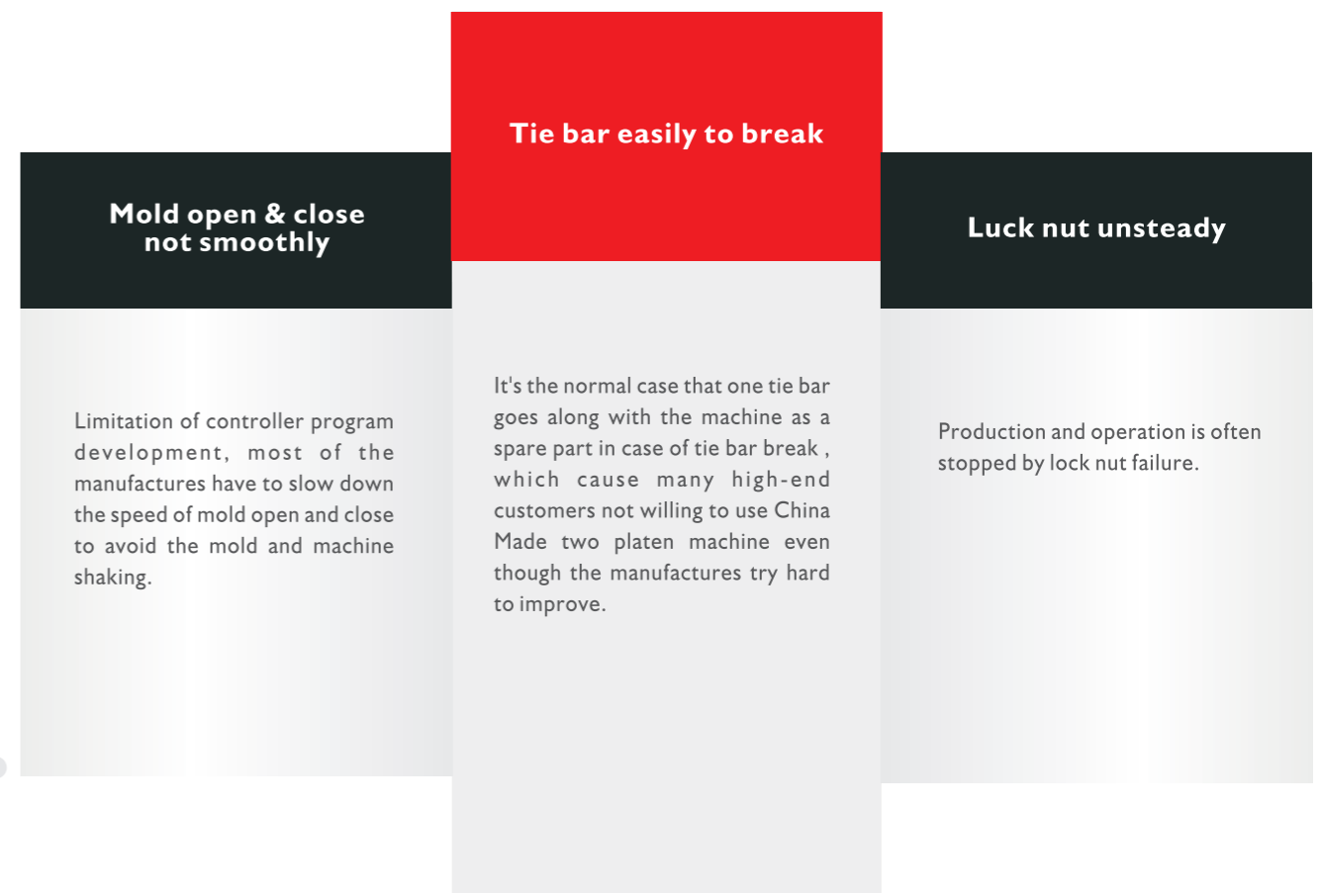

Bole two platen injection moulding machine can solve these problems effectively.

DK Series Two Platen Injection Moulding Machine

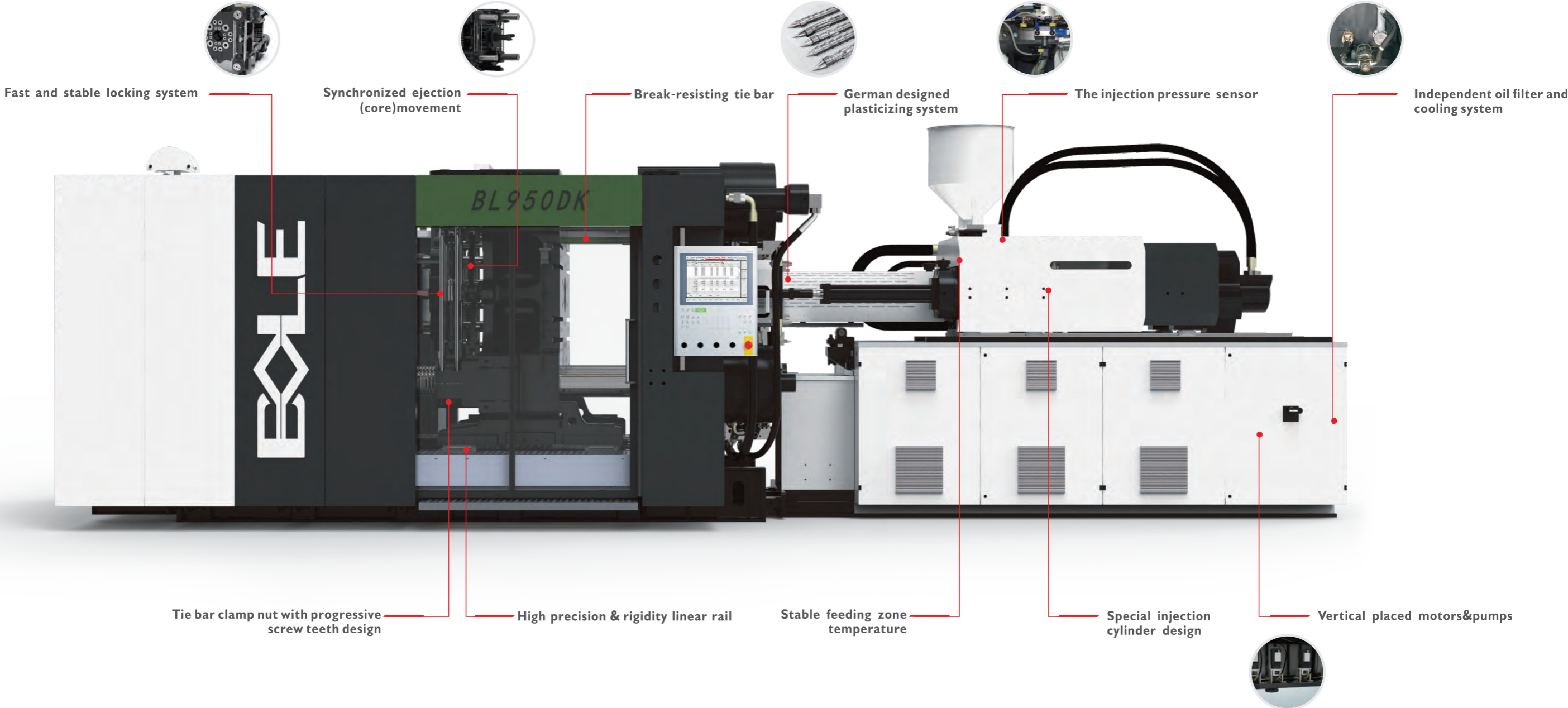

DK series two-platen injection moulding machine eleven core strengths



01 Break-resisting tie bar

Less stress for weak point of tie bar, there is almost no risk of fracture, high overload and bending resisted tie bar. Patent applied.

02 High precision & rigidity linear rail

DK series two platen machines adopt high-precision and high-rigidity liner guide coordinates with sliding foot to support movable platen, high guarantee.

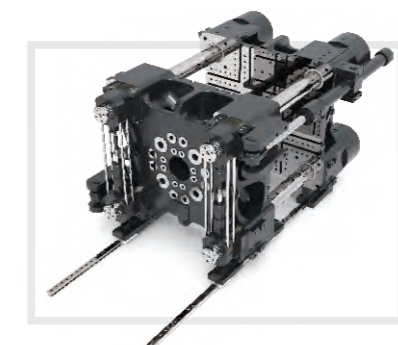
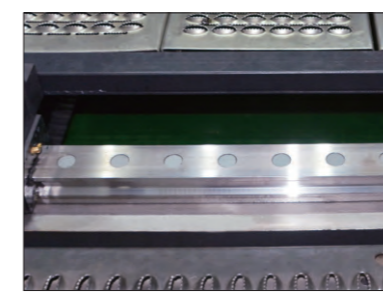
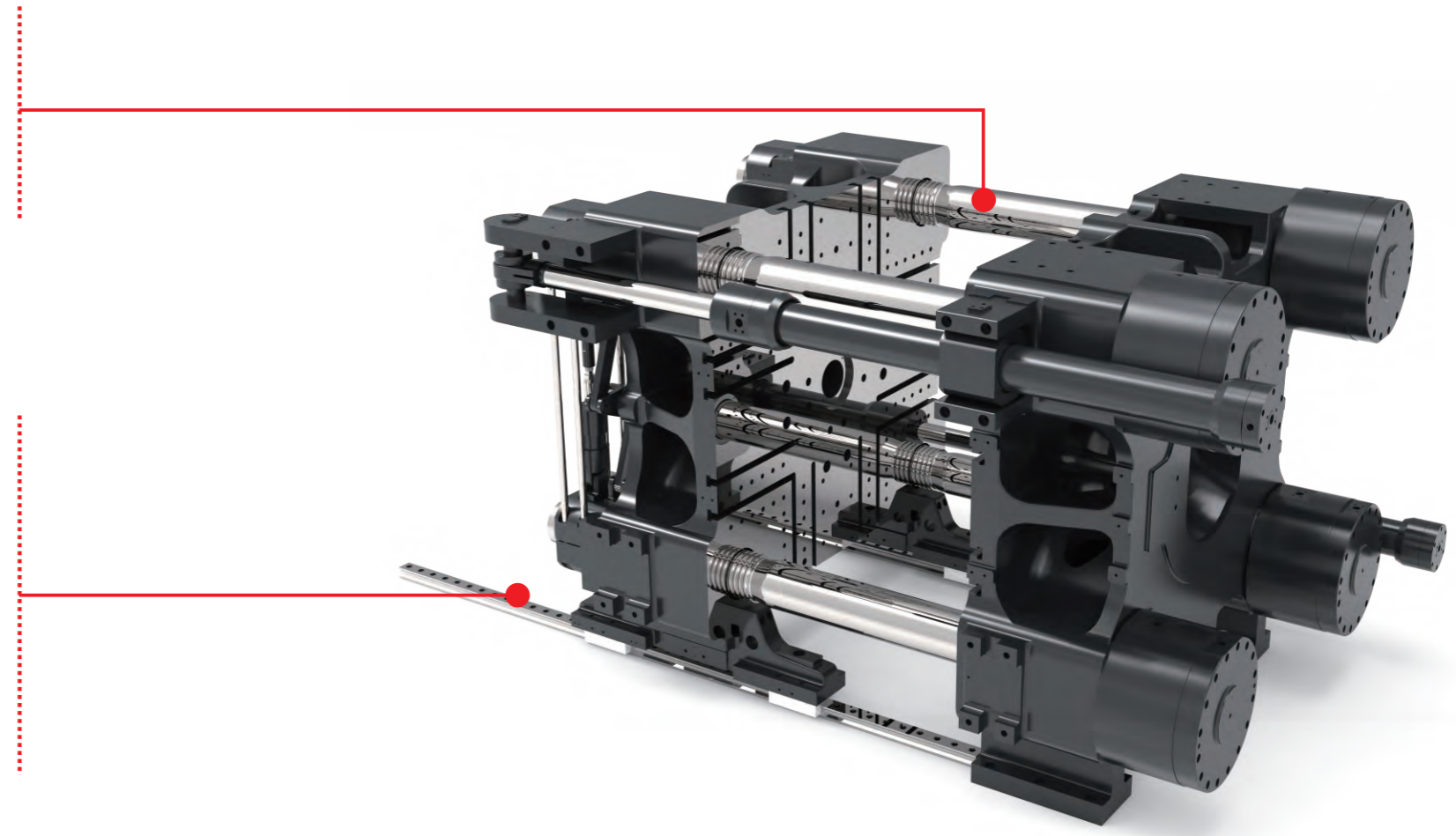

DK series two-platen injection moulding machine, developed by the German chief engineer, reshapes the Chinese two-platen injection machine market.



03 German Design Plasticizing System

- ⦿ Originate from German design Plasticizing System, efficiency excess above 20% of domestic level (Common plastics such as ABS, PS, PP, etc).
- ⦿ Custom made complicated technical requirement, applied to special plasticizing system.
- ⦿ All series can fit with A\B\C screw, L/D ratio 23:1, to achieve the best plasticizing effect and efficiency.

04 Vertical placed motors&pumps

The vertical arrangement of the motor reduces the area occupied, and reduces the influence of the bias load caused by the gravity of the motor rotor, which makes the motor more stable.



05 Fast and stable locking system

Fast, smooth, quiet, more effective lock nut to protect tie bar and the nut itself, prolong equipment lifetime.

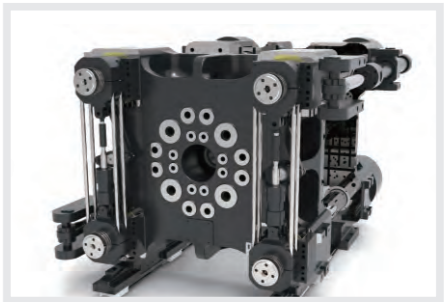

06 Synchronized ejection (core)movement

Synchronized eject (core pulling) function as standard, improve machine cycle efficiency.

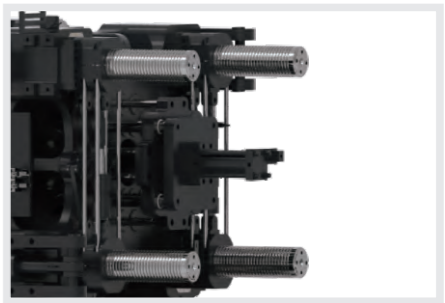

07 Special injection cylinder design

The new injection cylinder has extremely low oil return resistance and cooperates with the frame structure of the linear guide to reduce the friction of the injection part and greatly improve the control precision of the injection unit.



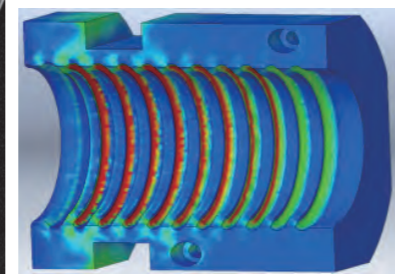
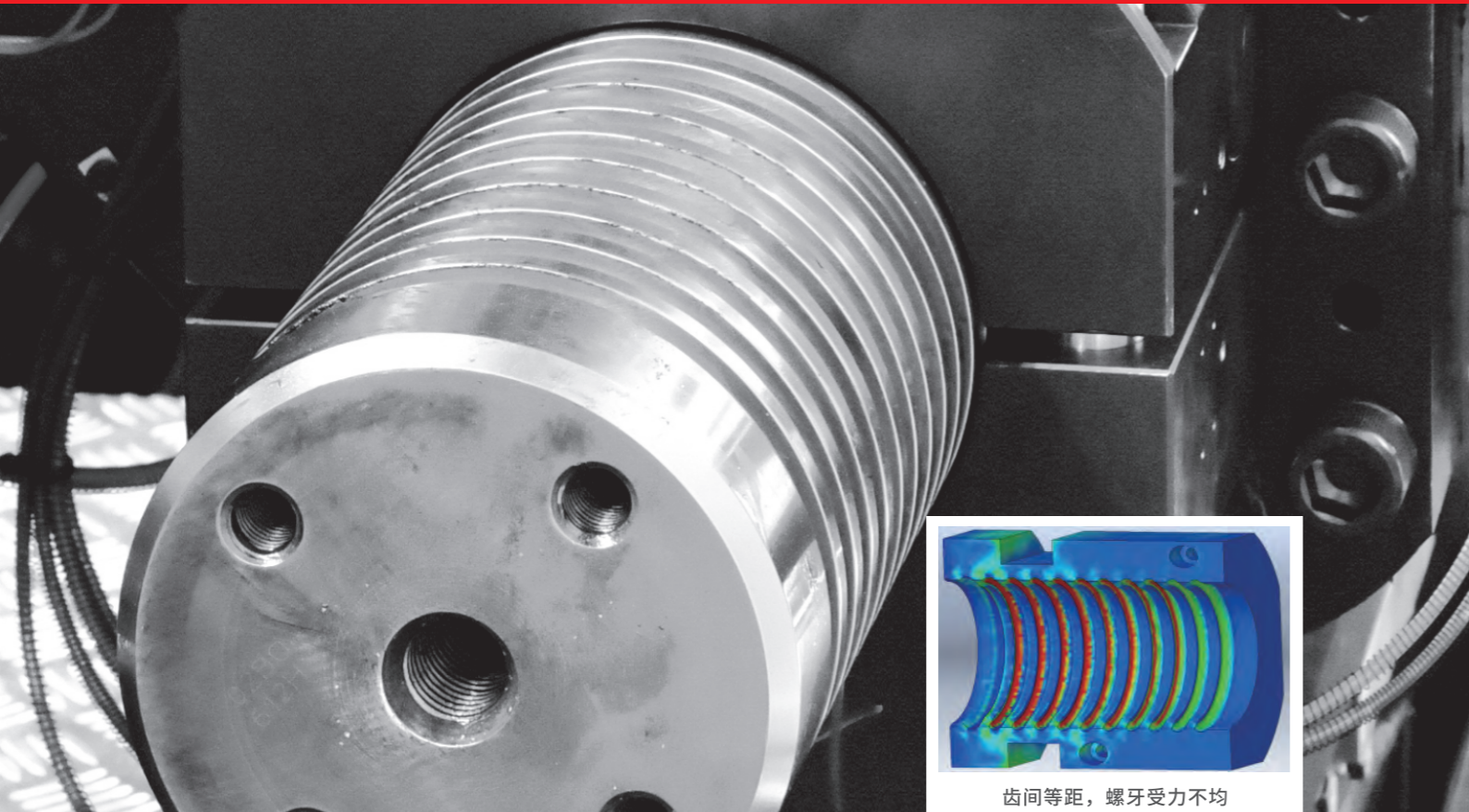

齿间等距，螺牙受力不均
Same tooth spacing, force not even

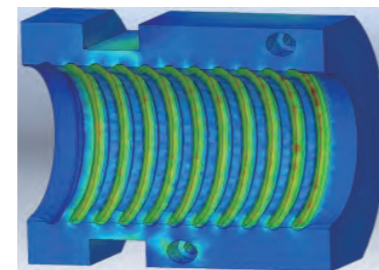

齿间变距设计，螺牙受力均匀
Variable tooth spacing, force even

08 Tie bar clamp nut with progressive screw teeth design

Even stress on each teeth, longer life time for locking nuts.

09 Independent oil filter and cooling system

Very compact and less space occupation. Stabilize the entire oil temperature without any other interruption, such as cycle time and other working elements.



10 Stable feeding zone temperature

The feed throat temperature is brought into the closed loop control of the temperature unit, thus the efficiency and precision of the whole injection molding unit are improved. To avoid low injection accuracy due to inconsistency and caking.



11 The injection pressure sensor

The injection pressure sensor gets feedback always, and the injection curve makes it easier for the customer to adjust the process of the product.

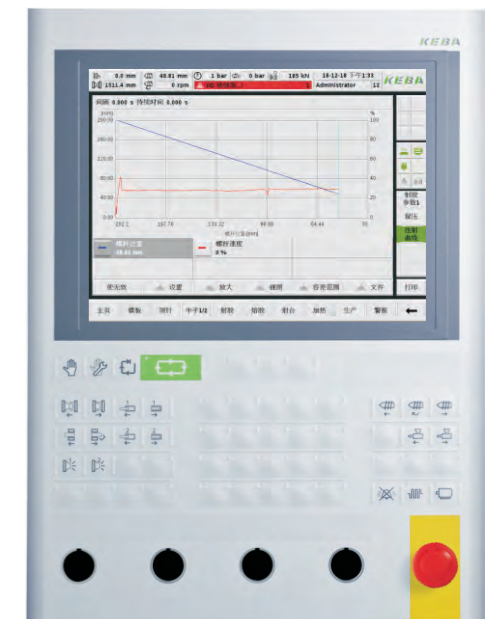
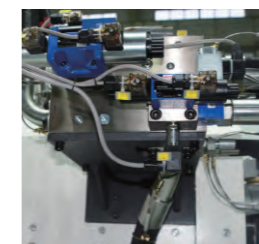

New Shape And Structure Of Sheet Metals

New design ensures the stabilization meanwhile reduce the cost, more simple, more pretty, and easier to produce.

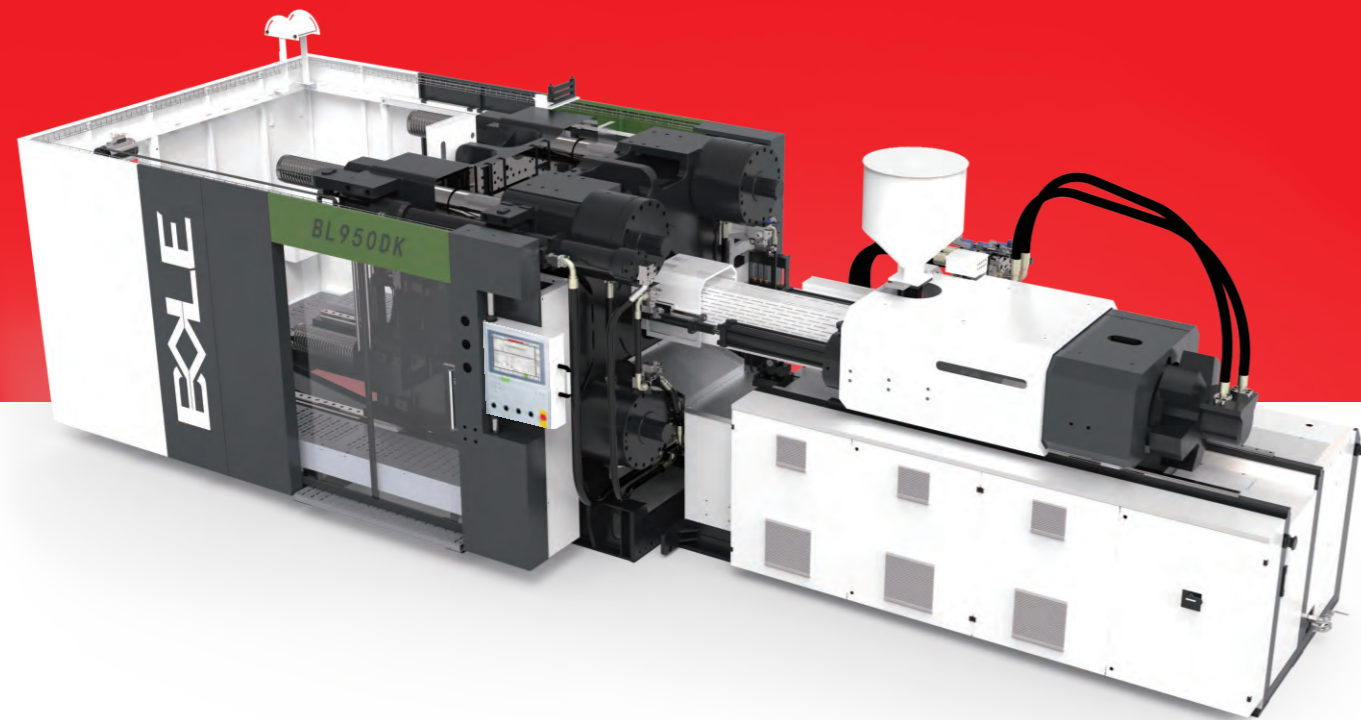

Various Application

